

GARMIN[®]

Edge[®] 20/25



Owner's Manual

All rights reserved. Under the copyright laws, this manual may not be copied, in whole or in part, without the written consent of Garmin. Garmin reserves the right to change or improve its products and to make changes in the content of this manual without obligation to notify any person or organization of such changes or improvements. Go to www.garmin.com for current updates and supplemental information concerning the use of this product.

Garmin®, the Garmin logo, ANT+®, Auto Lap®, Auto Pause®, and Edge® are trademarks of Garmin Ltd. or its subsidiaries, registered in the USA and other countries. Garmin Connect™ and Garmin Express™ are trademarks of Garmin Ltd. or its subsidiaries. These trademarks may not be used without the express permission of Garmin.

The Bluetooth® word mark and logos are owned by the Bluetooth SIG, Inc. and any use of such marks by Garmin is under license. Mac® is a trademark of Apple Inc., registered in the U.S. and other countries. Windows® is a registered trademark of Microsoft Corporation in the United States and other countries.

This product is ANT+® certified. Visit www.thisisant.com/directory for a list of compatible products and apps.

M/N: A02643

Table of Contents

Introduction	1
Keys.....	1
Status Icons.....	1
Installing the Standard Mount.....	1
Releasing the Edge.....	1
Going for a Ride.....	1
Charging the Device.....	1
Training	2
Setting the Ride Mode.....	2
Editing the Time, Distance, or Calorie Goal.....	2
Changing the Ride Mode.....	2
Training Indoors.....	2
Marking Laps.....	2
Using Auto Pause®.....	2
Using Auto Scroll.....	2
Changing Data Fields.....	2
History	2
Viewing Your Ride.....	2
Deleting a Ride.....	2
Personal Records.....	2
Viewing Your Personal Records.....	2
Deleting Personal Records.....	3
Viewing Bike Totals.....	3
Resetting Bike Totals.....	3
Garmin Connect.....	3
Sending Data to Your Garmin Connect Account.....	3
Data Management.....	3
Disconnecting the USB Cable.....	3
Bluetooth Connected Features.....	3
Pairing Your Smartphone with Your Edge 25.....	3
Turning Off Bluetooth Technology.....	3
Turning Off Smart Notifications.....	3
Navigation	4
Courses.....	4
Following a Course from the Web.....	4
Racing Against a Segment.....	4
Viewing Course Details.....	4
Deleting a Course.....	4
Course Options.....	4
ANT+ Sensors	4
Putting On the Optional Heart Rate Monitor.....	4
Installing the Cadence Sensor.....	5
Pairing ANT+ Sensors.....	5
Setting Your Maximum Heart Rate.....	5
About Heart Rate Zones.....	5
Fitness Goals.....	5
Setting Heart Rate Alerts.....	5
Customizing Your Device	5
Setting Up Your User Profile.....	5
System Settings.....	5
Time Settings.....	6
Device Information	6
Specifications.....	6
Edge Specifications.....	6
Heart Rate Monitor Specifications.....	6
Speed Sensor and Cadence Sensor Specifications.....	6
Device Care.....	6
Cleaning the Device.....	6
Caring for the Heart Rate Monitor.....	6
User Replaceable Batteries.....	6
Replacing the Heart Rate Monitor Battery.....	6
Replacing the Speed Sensor or Cadence Sensor Battery.....	7

Troubleshooting	7
Updating the Software.....	7
Support and Updates.....	7
Getting More Information.....	7
Maximizing Battery Life.....	7
Acquiring Satellite Signals.....	7
Resetting the Device.....	7
Replacement O-rings.....	7
Viewing Device Information.....	7
Appendix	7
Data fields.....	7
Heart Rate Zone Calculations.....	8
Software License Agreement.....	8
Index	9

Introduction

⚠ WARNING

See the *Important Safety and Product Information* guide in the product box for product warnings and other important information.

Always consult your physician before you begin or modify any exercise program.

Keys



①	☀ ⏻	Select to turn the backlight on and off. Hold to turn the device on and off.
②	▶	Select to start and stop the timer. Select to choose an option or to acknowledge a message.
③	▼	Select to scroll through the data screens, options, and settings. From the home screen, select to view the device menu.
④	↶	Select to mark a new lap. Select to return to the previous screen.

Status Icons

A solid icon means the signal was found or the sensor is connected.

	GPS status
	Bluetooth® status
	Heart rate status
	Speed and cadence status
	LiveTrack status

Installing the Standard Mount

For the best GPS reception, position the bike mount so the front of the device is oriented toward the sky. You can install the bike mount on the stem or the handlebars.

- 1 Select a secure location to mount the device where it does not interfere with the safe operation of your bike.
- 2 Place the rubber disk ① on the back of the bike mount.
The rubber tabs align with the back of the bike mount so it stays in place.

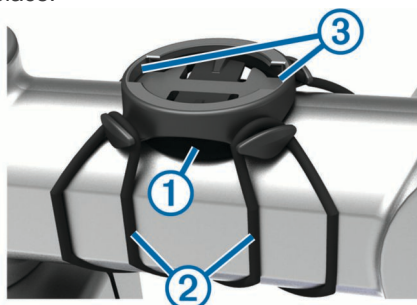

- 3 Place the bike mount on the bike stem.
- 4 Attach the bike mount securely using the two bands ②.

- 5 Align the tabs on the back of the device with the bike mount notches ③.
- 6 Press down slightly and turn the device clockwise until it locks into place.



Releasing the Edge

- 1 Turn the Edge clockwise to unlock the device.
- 2 Lift the Edge off the mount.

Going for a Ride

The device comes partially charged. You may need to charge the device ([Charging the Device, page 1](#)) before going for a ride. If your Edge 25 device was packaged with an ANT+® sensor, they are already paired.

- 1 Hold ⏻ to turn on the device.
 - 2 From the home screen, select ▶.
 - 3 Go outside, and wait while the device locates satellites. The satellite bars are solid when the device is ready.
 - 4 Select ▶ to start the timer.
- NOTE:** History is recorded only while the timer is running.
- 5 Select ▼ for additional data pages.

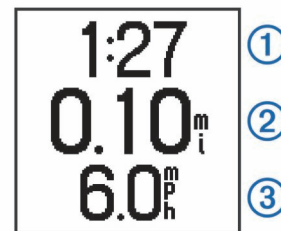

Time ①, distance ②, speed ③, total ascent, and calories are recorded while the timer is running. When using an optional heart rate monitor, your beats per minute and heart rate zone appear.

TIP: You can customize the data fields ([Changing Data Fields, page 2](#)).

- 6 Select ▶ to stop the timer.
- 7 Select **Save**.

Charging the Device

⚠ WARNING

This device contains a lithium-ion battery. See the *Important Safety and Product Information* guide in the product box for product warnings and other important information.

NOTICE

To prevent corrosion, thoroughly clean and dry the contacts and the surrounding area before charging or connecting to a computer. Refer to the cleaning instructions in the appendix.

- 1 Plug the USB cable into a USB port on your computer.
- 2 Align the charger posts with the contacts on the back of the device, and press the charger ① until it clicks.



- 3 Charge the device completely.

Training

Setting the Ride Mode

- 1 Select **▶** > **Ride Options** > **Ride Mode**.
- 2 Select an option:
 - Select **Basic** to go for an outdoor ([Going for a Ride, page 1](#)) or indoor ride ([Training Indoors, page 2](#)).
 - NOTE:** This is the default ride mode.
 - Select **Follow Course** to follow a course downloaded from your Garmin Connect™ account ([Following a Course from the Web, page 4](#)).
 - Select **Time** to train toward a specific time goal.
 - Select **Distance** to train toward a specific distance goal.
 - Select **Calories** to train toward a specific calorie goal.
- 3 If necessary, enter a custom value for the time, distance, or calorie goal.
- 4 Select **↵**.

When you reach the time, distance, or calorie goal, a message appears. The device also beeps if audible tones are turned on ([System Settings, page 5](#)).

Editing the Time, Distance, or Calorie Goal

When training toward a time, distance, or calorie goal, you can edit the current ride mode to change the goal setting.

- 1 Select **▶** > **Ride Options** > **Ride Mode** > **Edit**.
- 2 Enter a custom value.
- 3 Select **↵**.

Changing the Ride Mode

- 1 Select **▶** > **Ride Options** > **Ride Mode** > **Change Mode**.
- 2 Select an option.
- 3 If training toward a time, distance, or calorie goal, enter a custom value.
- 4 If following a course, select a course downloaded from your Garmin Connect account.
- 5 Select **↵**.

Training Indoors

You can turn off GPS when you are training indoors or to save battery life.

- 1 Select **▶** > **Ride Options** > **Use Indoors**.
The device enters timer mode.
- 2 Select **▶** to start the timer.

When GPS is off, speed and distance are not available unless you have an optional speed sensor that sends speed and distance data to the device (Edge 25 device only). The next time you turn on the device, it searches for satellite signals.

Marking Laps

You can use the Auto Lap® feature to mark a lap at a specific distance automatically (for example, every 1 mi. or 5 km), and you can mark laps manually. This feature is helpful for comparing your performance over different parts of an activity.

- 1 Select **▼** > **Settings** > **Ride Settings** > **Laps**.
- 2 Select an option:
 - Select **Auto Lap**, and select a distance to use the Auto Lap feature.
 - Select **Lap Key** > **Turn On** to use **↵** to mark a lap during an activity.

Using Auto Pause®

You can use the Auto Pause feature to pause the timer automatically when you stop moving. This feature is helpful if your activity includes stop lights or other places where you need to stop.

NOTE: The paused time is not saved with your history data.

- Select **▼** > **Settings** > **Ride Settings** > **Auto Pause** > **Turn On**.

Using Auto Scroll

You can use the Auto Scroll feature to cycle through the training data pages automatically while the timer is running.

- 1 Select **▼** > **Settings** > **Ride Settings** > **Auto Scroll**.
- 2 Select a display speed.

Changing Data Fields

You can change the data field combinations for the pages that appear while the timer is running.

- 1 Select **▼** > **Settings** > **Ride Settings** > **Data Fields**.
- 2 Select a page.
- 3 Select a data field to change it.

History

History includes time, distance, calories, speed, lap data, elevation, and optional ANT+ sensor information.

NOTE: History is not recorded while the timer is stopped or paused.

When the device memory is full, your oldest data is overwritten. You should upload your history to Garmin Connect periodically to keep track of all your ride data.

Viewing Your Ride

- 1 Select **▼** > **History** > **Rides**.
- 2 Select a ride.

Deleting a Ride

- 1 Select **▼** > **History** > **Rides**.
- 2 Select a ride.
- 3 Select **▶** > **Discard** > **Yes**.

Personal Records

When you complete a ride, the device displays any new personal records you achieved during that ride. Personal records include your fastest time over a standard distance, longest ride, and most ascent gained during a ride.

Viewing Your Personal Records

- 1 Select **▼** > **History** > **Records**.
- 2 Select **▼** to scroll through your records.

Deleting Personal Records

- 1 Select ▼ > **History** > **Records**.
- 2 Select a record to delete.
- 3 Select **Clear?** > **Yes**.

Restoring a Personal Record

You can set each personal record back to the one previously recorded.

- 1 Select ▼ > **History** > **Records**.
- 2 Select a record to restore.
- 3 Select **Use Previous** > **Use Record**.

Viewing Bike Totals

You can view the accumulated data you have saved to the Edge device, including the number of rides, time, and distance.

- 1 Select ▼ > **History** > **Totals**.
- 2 Select an option to view trip or device totals.

Resetting Bike Totals

- 1 Select ▼ > **History** > **Totals** > **Reset**.
- 2 Select an option to reset device or trip totals.

TIP: You can reset trip totals and retain device totals to record a new trip log.

- 3 Select **Yes**.

NOTE: This does not delete any saved activities.

Garmin Connect

You can connect with your friends on Garmin Connect. Garmin Connect gives you the tools to track, analyze, share, and encourage each other. Record the events of your active lifestyle including runs, walks, rides, swims, hikes, triathlons, and more. To sign up for a free account, go to www.garminconnect.com/start.

Store your activities: After you complete and save an activity with your device, you can upload that activity to Garmin Connect and keep it as long as you want.

Analyze your data: You can view more detailed information about your activity, including time, distance, elevation, heart rate, calories burned, cadence, an overhead map view, pace and speed charts, and customizable reports.

NOTE: Some data requires an optional accessory such as a heart rate monitor.

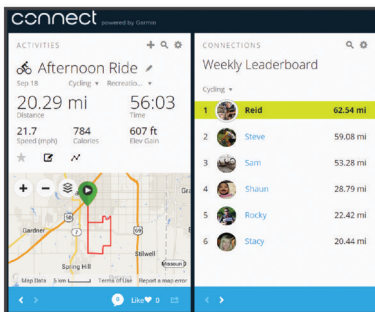

Share your activities: You can connect with friends to follow each other's activities or post links to your activities on your favorite social networking sites.

Sending Data to Your Garmin Connect Account

You can upload all of your activity data to your Garmin Connect account for comprehensive analysis. You can view a map of your activity and share your activities with friends.

- 1 Connect the device to your computer using the USB cable.
- 2 Go to www.garminconnect.com.
- 3 Follow the on-screen instructions.

Data Management

NOTE: The device is not compatible with Windows® 95, 98, Me, Windows NT®, and Mac® OS 10.3 and earlier.

Deleting Files

NOTICE

If you do not know the purpose of a file, do not delete it. Your device memory contains important system files that should not be deleted.

- 1 Open the **Garmin** drive or volume.
- 2 If necessary, open a folder or volume.
- 3 Select a file.
- 4 Press the **Delete** key on your keyboard.

Disconnecting the USB Cable

If your device is connected to your computer as a removable drive or volume, you must safely disconnect your device from your computer to avoid data loss. If your device is connected to your Windows computer as a portable device, it is not necessary to safely disconnect.

- 1 Complete an action:
 - For Windows computers, select the **Safely Remove Hardware** icon in the system tray, and select your device.
 - For Mac computers, drag the volume icon to the trash.
- 2 Disconnect the cable from your computer.

Bluetooth Connected Features

The Edge 25 device has several Bluetooth connected features for your compatible smartphone or mobile device using the Garmin Connect Mobile app. For more information, go to www.garmin.com/intosports/apps.

LiveTrack: Allows friends and family to follow your races and training activities in real time. You can invite followers using email or social media, allowing them to view your live data on a Garmin Connect tracking page.

Activity uploads: Automatically sends your activity to Garmin Connect Mobile as soon as you finish recording the activity.

Social media interactions: Allows you to post an update to your favorite social media website when you upload an activity to Garmin Connect Mobile.

Notifications: Displays call and text alerts on your Edge 25 device.

Pairing Your Smartphone with Your Edge 25

- 1 Go to www.garmin.com/intosports/apps, and download the Garmin Connect Mobile app to your smartphone.
- 2 Bring your smartphone within 10 m (33 ft.) of your device.
- 3 From the Edge 25 device, select ▼ > **Settings** > **Bluetooth** > **Pair Smartphone**.
- 4 Open the Garmin Connect Mobile app, and follow the on-screen instructions to connect a device.

The instructions are provided during the initial setup, or can be found in the Garmin Connect Mobile app help.

Turning Off Bluetooth Technology

- From the Edge 25 device, select ▼ > **Settings** > **Bluetooth** > **Turn Off**.
- See the owner's manual for your smartphone to turn off Bluetooth wireless technology.

Turning Off Smart Notifications

From the Edge 25 device, select ▼ > **Settings** > **Bluetooth** > **Smart Notifications** > **Turn Off**.

Navigation

Courses

You can send a course from your Garmin Connect account to your device. After it is saved to your device, you can navigate the course on your device.

You can follow a saved course simply because it is a good route. For example, you can save and follow a bike friendly commute to work. You can also follow a saved course, trying to match or exceed previously set performance goals.

Following a Course from the Web

Before you can download a course from your Garmin Connect account, you must have a Garmin Connect account www.garminconnect.com/start.

- 1 Connect the device to your computer using the USB cable.
- 2 Go to ([Sending Data to Your Garmin Connect Account, page 3](#)).
- 3 Create a new course, or select an existing course.
- 4 Select **Send to Device**.
- 5 Disconnect the device.
- 6 Select ▼ > **Courses**.
- 7 Select a course.
- 8 Select **Do Course**.
- 9 Select ▶ to start the timer.

The map displays the course and a progress bar at the top of the screen.

- 10 If necessary, select ▼ for additional data pages.

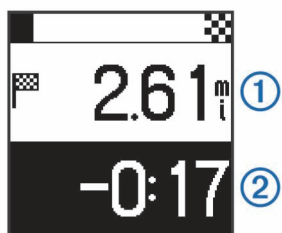

You can view the distance to the end of the course ①, and your time ahead or behind the course time ②.

Racing Against a Segment

You can download courses containing segments from your Garmin Connect account. Segments are virtual race courses. You can race against a segment, and compare your performance to past activities, connections in your Garmin Connect account, or other members of the Garmin Connect community. You can upload your activity data to your Garmin Connect account to view your segment position.

- 1 Start following a course containing a segment ([Following a Course from the Web, page 4](#)).

When you are near the starting point of a segment, a message appears.

- 2 Start racing against the segment.

The device displays the time spent in the segment.

A message appears when the segment is complete.

Viewing Course Details

- 1 Select ▼ > **Courses**.
- 2 Select a course.
- 3 Select an option:
 - Select **Details** to view the time, distance, and total ascent of the course.
 - Select **Map** to view the course on the map.

Map Features

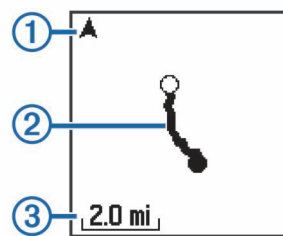

①	Points to north
②	Course outline
③	Zoom level

Deleting a Course

- 1 Select ▼ > **Courses**.
- 2 Select a course.
- 3 Select **Delete** > **Yes**.

Course Options

Select ▼ > **Settings** > **Course Options**.

Turn Prompts: Enables or disables turn-by-turn navigation prompts.

Segment Prompts: Enables or disables prompts alerting you to approaching segments.

ANT+ Sensors

The Edge 25 device can be used with wireless ANT+ sensors. For more information about compatibility and purchasing optional sensors, go to <http://buy.garmin.com>.

Putting On the Optional Heart Rate Monitor

NOTICE

The heart rate monitor may cause chafing when used for long periods of time. To alleviate this issue, apply an anti-friction lubricant or gel to the center of the module where it contacts your skin. Do not apply anti-friction gel or lubricant on the electrodes. Do not use gels or lubricants that contain sunscreen.

You should wear the heart rate monitor directly on your skin, just below your sternum. It should be snug enough to stay in place during your activity.

- 1 Push one tab ① of the strap through the slot ② in the heart rate monitor module.



- 2 Press the tab down.
- 3 Wet the electrodes ③ on the back of the module to create a strong connection between your chest and the heart rate monitor module.



- 4 Wrap the strap around your chest and attach it to the other side of the heart rate monitor module.

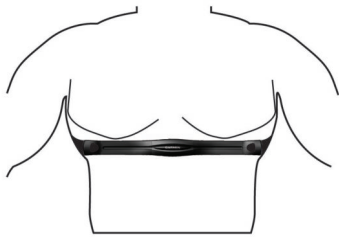

The Garmin® logo should be right-side up.

- 5 Bring the device within 3 m (10 ft.) of the heart rate monitor. After you put on the heart rate monitor, it is active and sending data.

Installing the Cadence Sensor

NOTE: If you do not have this sensor, you can skip this task.

TIP: Garmin recommends you secure your bike on a stand while installing the sensor.

- 1 Select the band size that fits your crank arm ① securely. The band you select should be the smallest one that stretches across the crank arm.
- 2 On the non-drive side, place and hold the flat side of the cadence sensor on the inside of the crank arm.
- 3 Pull the bands ② around the crank arm, and attach them to the hooks ③ on the sensor.

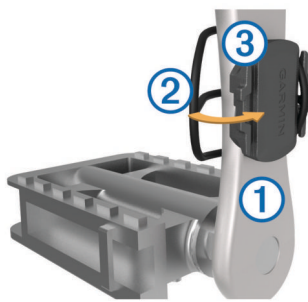

- 4 Rotate the crank arm to check for clearance. The sensor and bands should not contact any part of your bike or shoe.

NOTE: The LED flashes green for five seconds to indicate activity after two revolutions.
- 5 Take a 15 minute test ride and inspect the sensor and bands to ensure there is no evidence of damage.

Pairing ANT+ Sensors

The first time you connect an ANT+ sensor to your device, you must pair the device and sensor. After the initial pairing, the device automatically connects to the sensor when you start your activity and the sensor is active and within range.

NOTE: If your Edge 25 device was packaged with an ANT+ sensor, they are already paired.

- 1 Install the sensor or put on the heart rate monitor.
- 2 Select ▼ > **Settings** > **Connect Sensors**.
- 3 Bring the device within 1 cm of the sensor, and wait while the device connects to the sensor.

When the device detects the sensor, a message appears.

Setting Your Maximum Heart Rate

The device uses your user profile information from the initial setup to estimate your maximum heart rate and determine your default heart rate zones. The default maximum heart rate is 220 minus your age. For the most accurate calorie data during your activity, you should set your maximum heart rate (if known).

- 1 Select ▼ > **Settings** > **User Profile** > **Max. HR**.
- 2 Enter your maximum heart rate.

About Heart Rate Zones

Many athletes use heart rate zones to measure and increase their cardiovascular strength and improve their level of fitness. A heart rate zone is a set range of heartbeats per minute. The five commonly accepted heart rate zones are numbered from 1 to 5 according to increasing intensity. Generally, heart rate zones are calculated based on percentages of your maximum heart rate.

Fitness Goals

Knowing your heart rate zones can help you measure and improve your fitness by understanding and applying these principles.

- Your heart rate is a good measure of exercise intensity.
- Training in certain heart rate zones can help you improve cardiovascular capacity and strength.
- Knowing your heart rate zones can prevent you from overtraining and can decrease your risk of injury.

If you know your maximum heart rate, you can use the table ([Heart Rate Zone Calculations, page 8](#)) to determine the best heart rate zone for your fitness objectives.

If you do not know your maximum heart rate, use one of the calculators available on the Internet. Some gyms and health centers can provide a test that measures maximum heart rate. The default maximum heart rate is 220 minus your age.

Setting Heart Rate Alerts

If you have an optional heart rate monitor, you can set the device to alert you when your heart rate is above or below a target zone or a custom range. For example, you can set the device to alert you when your heart rate is below 150 beats per minute (bpm).

- 1 Select ▶ > **Ride Options** > **HR Alert**.
- 2 Select an option:
 - To use the range of an existing heart rate zone, select a heart rate zone.
 - To customize the maximum value, select **Custom** > **High** > **Turn On**, and enter a value.
 - To customize the minimum value, select **Custom** > **Low** > **Turn On**, and enter a value.

Each time you exceed or drop below the specified range or custom value, a message appears. The device also beeps if audible tones are turned on ([System Settings, page 5](#)).

Customizing Your Device

Setting Up Your User Profile

You can update your gender, birth year, height, weight, and maximum heart rate ([Setting Your Maximum Heart Rate, page 5](#)) settings. The device uses this information to calculate accurate training data.

- 1 Select ▼ > **Settings** > **User Profile**.
- 2 Select an option.

System Settings

Select ▼ > **Settings** > **System**.

Language: Sets the language displayed on the device.

Time: Sets the time settings ([Time Settings, page 6](#)).

Backlight Timeout: Sets the length of time before the backlight turns off.

Tones: Turns audible tones on or off. You can set tones for keys and alert messages.

Units: Sets the units of measure used on the device.

GLONASS: Turns GLONASS on or off. By default, the device uses GPS to locate satellites. For increased performance in challenging environments and faster GPS position location, you can enable GPS and GLONASS. Using GPS and GLONASS reduces battery life more quickly than using only GPS.

Software Update: Allows you to check for software updates.

About: Displays the software version and unit ID.

Time Settings

Select ▼ > **Settings** > **System** > **Time**.

Time Format: Sets the device to show time in a 12-hour or a 24-hour format.

Set Time: Allows you to set the time manually or automatically based on your GPS position.

Device Information

Specifications

Edge Specifications

Battery type	Rechargeable, built-in lithium-ion battery
Battery life	Up to 8 hr.
Operating temperature range	From -15° to 60°C (from 5° to 140°F)
Charging temperature range	From 0° to 45°C (from 32° to 113°F)
Radio frequency/protocol	2.4 GHz ANT+ wireless communications protocol (Edge 25 device only) Bluetooth Smart wireless technology (Edge 25 device only)
Water rating	IEC 60529 IPX7*

*The device withstands incidental exposure to water of up to 1 m for up to 30 min. For more information, go to www.garmin.com/waterrating.

Heart Rate Monitor Specifications

Battery type	User-replaceable CR2032, 3 volts
Battery life	Approximately 3 years (1 hour per day)
Operating temperature range	From -10° to 50°C (from 14° to 122°F)
Radio frequency/protocol	2.4 GHz ANT+ wireless communications protocol
Water rating	1 ATM* NOTE: This product does not transmit heart rate data while swimming.

*The device withstands pressure equivalent to a depth of 10 m. For more information, go to www.garmin.com/waterrating.

Speed Sensor and Cadence Sensor Specifications

Battery type	User-replaceable CR2032, 3 volts
Battery life	Approximately 12 months (1 hour per day)
Operating temperature range	From -20° to 60°C (from -4° to 140°F)
Radio frequency/protocol	2.4 GHz ANT+ wireless communications protocol
Water rating	1 ATM*

*The device withstands pressure equivalent to a depth of 10 m. For more information, go to www.garmin.com/waterrating.

Device Care

NOTICE

Avoid extreme shock and harsh treatment, because it can degrade the life of the product.

Avoid pressing the keys under water.

Do not use a sharp object to clean the device.

Avoid chemical cleaners, solvents, and insect repellents that can damage plastic components and finishes.

Thoroughly rinse the device with fresh water after exposure to chlorine, salt water, sunscreen, cosmetics, alcohol, or other harsh chemicals. Prolonged exposure to these substances can damage the case.

Do not store the device where prolonged exposure to extreme temperatures can occur, because it can cause permanent damage.

Cleaning the Device

NOTICE

Even small amounts of sweat or moisture can cause corrosion of the electrical contacts when connected to a charger. Corrosion can prevent charging and data transfer.

1 Wipe the device using a cloth dampened with a mild detergent solution.

2 Wipe it dry.

After cleaning, allow the device to dry completely.

Caring for the Heart Rate Monitor

NOTICE

A build up of sweat and salt on the strap can decrease the ability of the heart rate monitor to report accurate data.

- Rinse the strap after every use.
- Hand wash the strap occasionally, using a tiny amount of mild detergent, such as dishwashing liquid.
NOTE: Using too much detergent may damage the strap.
- Do not put the strap in a dryer.
- When drying the strap, hang it up or lay it flat.

User Replaceable Batteries

⚠ WARNING

Do not use a sharp object to remove batteries.

Keep the battery away from children.

Never put batteries in mouth. If swallowed, contact your physician or local poison control center.

Replaceable coin cell batteries may contain perchlorate material. Special handling may apply. See www.dtsc.ca.gov/hazardouswaste/perchlorate.

⚠ CAUTION

Contact your local waste disposal department to properly recycle the batteries.

Replacing the Heart Rate Monitor Battery

- 1 Locate the circular battery cover on the back of the heart rate monitor.



- 2 Use a coin to twist the cover counter-clockwise until it is loose enough to remove (the arrow points to **OPEN**).
- 3 Remove the cover and the battery.
- 4 Wait 30 seconds.
- 5 Insert the new battery with the positive side facing up.
NOTE: Do not damage or lose the O-ring gasket.
- 6 Use a coin to twist the cover clockwise back into place (the arrow points to **CLOSE**).

After you replace the heart rate monitor battery, you may need to pair the heart rate monitor with the device again.

Replacing the Speed Sensor or Cadence Sensor Battery

The LED flashes red to indicate a low battery level after two revolutions.

- 1 Locate the circular battery cover ① on the back of the sensor.



- 2 Twist the cover counter-clockwise until the marker points to unlocked and the cover is loose enough to remove.
- 3 Remove the cover and the battery ②.
TIP: You can use a piece of tape ③ or a magnet to remove the battery from the cover.



- 4 Wait 30 seconds.
- 5 Insert the new battery into the cover, observing polarity.
NOTE: Do not damage or lose the O-ring gasket.
- 6 Twist the cover clockwise until the marker points to locked.
NOTE: The LED flashes red and green for a few seconds after battery replacement. When the LED flashes green and then stops flashing, the device is active and ready to send data.

Troubleshooting

Updating the Software

Before you can update your device software, you must have a Garmin Connect account, and you must download the Garmin Express™ application.

- 1 Connect the device to your computer using the USB cable.
When new software is available, the Garmin Express application sends it to your device.
- 2 Follow the on-screen instructions.
- 3 Do not disconnect your device from the computer while the Garmin Express application downloads the software.
TIP: If you are having trouble updating the software with the Garmin Express application, you may need to upload your activity history to the Garmin Connect application and delete your activity history from the device. This should provide sufficient memory space for the update.

Support and Updates

Garmin Express (www.garmin.com/express) provides easy access to these services for Garmin devices.

- Product registration
- Product manuals
- Software updates
- Data uploads to Garmin Connect

Getting More Information

- Go to www.garmin.com/intosports.
- Go to www.garmin.com/learningcenter.
- Go to <http://buy.garmin.com>, or contact your Garmin dealer for information about optional accessories and replacement parts.

Maximizing Battery Life

- Turn off the Bluetooth wireless feature on your Edge 25 device (*Turning Off Bluetooth Technology*, page 3).
- Turn off **GLONASS** (*System Settings*, page 5).

Acquiring Satellite Signals



The device may need a clear view of the sky to acquire satellite signals. The time and date are set automatically based on the GPS position.

- 1 Go outdoors to an open area.
The front of the device should be oriented toward the sky.
- 2 Wait while the device locates satellites.
It may take 30–60 seconds to locate satellite signals.

Resetting the Device

If the device stops responding, you may need to reset it.

NOTE: Resetting the device may erase your data or settings.

- 1 Hold  for 15 seconds.
The device turns off.
- 2 Hold  for one second to turn on the device.

Replacement O-rings

Replacement bands (O-rings) are available for the mounts.

NOTE: Use Ethylene Propylene Diene Monomer (EPDM) replacement bands only. Go to <http://buy.garmin.com>, or contact your Garmin dealer.

Viewing Device Information

You can view the unit ID, software version, GPS version, and software information.

Select ▼ > **Settings** > **System** > **About**.

Appendix

Data fields

Some data fields require ANT+ accessories to display data (Edge 25 device only).

Avg. Speed: The average speed for the current activity.

BPM: Your heart rate in beats per minute (bpm). Your device must be connected to a compatible heart rate monitor.

Cadence: Cycling. The number of revolutions of the crank arm. Your device must be connected to a cadence accessory for this data to appear.

Calories: The amount of total calories burned.

Distance: The distance traveled for the current track or activity.

Elevation: The altitude of your current location above or below sea level.

HR Zone: The current range of your heart rate (1 to 5). The default zones are based on your user profile and maximum heart rate (220 minus your age).

Speed: The current rate of travel.

Time: The stopwatch time for the current activity.

Total Ascent: The total elevation distance ascended since the last reset.

Heart Rate Zone Calculations

Zone	% of Maximum Heart Rate	Perceived Exertion	Benefits
1	50–60%	Relaxed, easy pace, rhythmic breathing	Beginning-level aerobic training, reduces stress
2	60–70%	Comfortable pace, slightly deeper breathing, conversation possible	Basic cardiovascular training, good recovery pace
3	70–80%	Moderate pace, more difficult to hold conversation	Improved aerobic capacity, optimal cardiovascular training
4	80–90%	Fast pace and a bit uncomfortable, breathing forceful	Improved anaerobic capacity and threshold, improved speed
5	90–100%	Sprinting pace, unsustainable for long period of time, labored breathing	Anaerobic and muscular endurance, increased power

Software License Agreement

BY USING THE DEVICE, YOU AGREE TO BE BOUND BY THE TERMS AND CONDITIONS OF THE FOLLOWING SOFTWARE LICENSE AGREEMENT. PLEASE READ THIS AGREEMENT CAREFULLY.

Garmin Ltd. and its subsidiaries (“Garmin”) grant you a limited license to use the software embedded in this device (the “Software”) in binary executable form in the normal operation of the product. Title, ownership rights, and intellectual property rights in and to the Software remain in Garmin and/or its third-party providers.

You acknowledge that the Software is the property of Garmin and/or its third-party providers and is protected under the United States of America copyright laws and international copyright treaties. You further acknowledge that the structure, organization, and code of the Software, for which source code is not provided, are valuable trade secrets of Garmin and/or its third-party providers and that the Software in source code form remains a valuable trade secret of Garmin and/or its third-party providers. You agree not to decompile, disassemble, modify, reverse assemble, reverse engineer, or reduce to human readable form the Software or any part thereof or create any derivative works based on the Software. You agree not to export or re-export the Software to any country in violation of the export control laws of the United States of America or the export control laws of any other applicable country.

Index

A

accessories 4, 7
alerts 5
ANT+ sensors 4
applications 3
 smartphone 3
Auto Lap 2
Auto Pause 2
Auto Scroll 2

B

backlight 1
bands 7
battery
 charging 1
 maximizing 3, 5, 7
 replacing 6, 7
Bluetooth technology 1, 3

C

charging 1
cleaning the device 6
clock 6
courses 4
 deleting 4
 loading 4

D

data
 storing 3
 transferring 3
data fields 2, 7
deleting
 all user data 3
 history 3
 personal records 3

G

Garmin Connect 3, 4
Garmin Express
 registering the device 7
 updating software 7
GPS 1
 signal 7
 stopping 2

H

heart rate 1
 alerts 5
 monitor 4–6
 zones 5, 8
history 1–3
 deleting 2, 3
 sending to computer 3

I

icons 1
installing 1, 5

K

keys 1, 6

L

laps 1, 2

M

maps 4
 updating 7
menu 1
mounting the device 1

N

navigation 4

O

O-rings. *See* bands

P

pairing
 ANT+ sensors 5

 smartphone 3
personal records 2
 deleting 3
 restoring 3
product registration 7
profiles, user 5

R

registering the device 7
replacing the battery 6
resetting the device 7

S

satellite signals 7
saving activities 1
segments 4
settings 5, 6
smartphone 3
 applications 3
 pairing 3
software
 updating 7
 version 7
software license agreement 8
specifications 6
speed and cadence sensors 1, 5, 7
storing data 3
system settings 5

T

time, settings 6
timer 1, 2
training 3
 modes 2
 pages 1
troubleshooting 7

U

unit ID 7
updates, software 7
USB 7
 disconnecting 3
user data, deleting 3
user profile 5

Z

zones, heart rate 5

www.garmin.com/support



1800 235 822



+43 (0) 820 220230



+ 32 2 672 52 54



0800 770 4960



1-866-429-9296



+385 1 5508 272
+385 1 5508 271



+420 221 985466
+420 221 985465



+ 45 4810 5050



+ 358 9 6937 9758



+ 331 55 69 33 99



+ 39 02 36 699699



(+52) 001-855-792-7671



0800 427 652



0800 0233937



+47 815 69 555



00800 4412 454
+44 2380 662 915



+35 1214 447 460



+386 4 27 92 500



0861 GARMIN (427 646)
+27 (0)11 251 9800



+34 93 275 44 97



+ 46 7744 52020



+886 2 2642-9199 ext 2



0808 238 0000
+44 870 850 1242



+49 (0) 89 858364880
zum Ortstarif - Mobilfunk
kann abweichen



913-397-8200
1-800-800-1020

